



3570 Series

Cylinder Mortice Locks



An ASSA ABLOY Group brand

ASSA ABLOY



Cylinder Mortice Locks

Contents

| Description | Page |
|------------------------------------|-------------|
| 3570 General Information | 3 |
| 3570 Standard Backset | 4 |
| 3570 Ordering Procedure | 5 |
| 3570 Nightlatches | 6-7 |
| 3571 Deadlocks | 8-9 |
| 3572 Vestibule Locks | 10-11 |
| 3573 Sliding Door Deadlocks | 12-13 |
| 3574 Combination Latches | 14-15 |
| 3577 Dual Entry Deadlatch | 16 |
| 3578 Hold Back Deadlatches | 17 |
| 3570 Accessories | 18-19 |
| 3570 Cylinder/Cam & Adaptors Chart | 20 |
| 3570 Cam/Adaptor Function Chart | 21 |

Cylinder Mortice Locks

3570 Series General Information

Application

A wide range of security cylinder mortice locks and latches suitable for heavy duty use in industrial and commercial buildings, institutions, clubs, schools, hospitals, hotels and similar buildings.

Features & Specifications

All 3570 Series cylinder mortice locks are built of the finest materials, with the easy action and solid feel of the world's finest locks.

Case & Cover Plates

High purity zinc alloy material cases and stainless steel cover plates.

Brass plates provided for plated finishes available in square and round end.

Backset

60 mm standard backset.

Extended backsets 89 and 127 mm are available on application. (Refer to Ordering Procedure).

Latchbolts

Latchbolts are 15 mm, stainless steel and are rated to 4 hours on fire door assemblies in accordance with Australian Standard AS 1905, Part 1 Fire Resistant Doorsets.

Deadlatching is achieved by an auxiliary stainless steel latchbolt. This auxiliary bolt retracts when the main latchbolt is withdrawn when the door is closed.

Deadbolts

Deadbolts are 19 mm, stainless steel.

Springs

High-grade spring steel material, corrosion protected.

Cylinder Retaining Pin

Hard-drawn spring steel wire, corrosion protected.

Door Thickness

32 to 50 mm. Locksets to suit thicker doors are available on application.

Cylinder

Five pin tumbler mechanism. Standard Lockwood oval shaped, brass cylinders and brass plugs.

Door Clearance

To ensure correct functioning of the deadlatching mechanism and security for all locks, the clearance between the door and frame should be 3 mm. However the deadlatching will operate up to 8 mm door clearance.

Aluminium Doors

Aluminium door accessory packs and aluminium fix locks are available upon request. Specify SP3570 - 419 for mounting tabs accessory pack or 3572AFSC for complete primary lock.

Security

All 3570 Series Cylinder Mortice Locks conform with Level S2 (Physical Security) Australian Lock Standard (AS-4145.2-1993). Conformance with Level S3 (Physical Security) is available upon request.

Durability

All 3570 Series Cylinder Mortice Locks conform with level D3 (Durability) Australian Lock Standard (AS 4145.2-1993). Lockwood 3570 Series Mortice Locks have been successfully tested up to 4 Hours (depending on type of doorset) on fire door assemblies in accordance with Australian Standard AS 1905.1- 1997, Part 1: Fire resistant doorsets.

Keying

Standard keying

Supplied individually keyed with two keys per lock. 78,000 key combinations. Key blank KB2015P.

Special Keying

Can be keyed alike, master keyed, grand master keyed, maison keyed or construction keyed in Lockwood security keying systems.

Standard Finishes

| | |
|-------------------|----|
| Bright Chrome | CP |
| Satin Chrome | SC |
| Florentine Bronze | FB |
| Polished Brass | PB |

Specification Service

For all architectural hardware specification assistance refer to your local ASSA ABLOY Sales Office.

A fully comprehensive, obligation free, architectural door hardware specification can be prepared by ASSA ABLOY Architectural Hardware Consultants.

Round Cylinders

Round cylinders are available to suit round rose door furniture.

Refer accessories Page 19.

Extended Cylinders

Extended cylinders are available for thicker doors. Refer accessories Page 19.

Rebate

Rebate kits to suit 13 mm standard rebate are available - refer accessories.

Electric Strikes

Lockwood 3570 Series Mortice Locks are compatible with most electric strikes. Refer local sales office for further details.

Cylinder Mortice Locks

3570 Series Standard Backset

1. Hub Selection

A patent protected cam operated adjustment of locking members attached to the snib and accessible through the lock body from the outside to set hubs as required.

2. Latch Bolt

Reversible for both left and right hand doors opening in or opening out without disassembly.

Standard deadlatch configuration, except for passage latch function.

Separate auxiliary bolt moves into lock case simultaneously with latch bolt.

Bolt – standard stainless steel fire rated to 4 hours. Electric strike compatibility.

3. Strike

Universal stainless steel strike suitable for 4 hour fire rating applications.

4. Door Thickness

Standard applications 32 to 50 mm.

5. Backsets

60 mm standard, 89 mm and 127 mm available on application.

6. Cylinder/Adaptor Retention

Patented "Slip Pin" Cylinder/Adaptor fixing method, which allows attachment to the case by inserting a non threaded cylindrical pin through the front of the lock case.

7. Multi-Function Lock

Lock is designed to significantly reduce stock line items.

Standard cylinder mortice lock can be converted from escape function to combination function by simple manipulation of hub snibs without lock case disassembly.

8. Case Assembly

High purity zinc alloy case and backplate.

9. Cylinder Assembly

Five pin tumbler mechanism. Standard Lockwood oval shaped, Brass cylinders and Brass plugs.

10. Kick-Off Selection

A removable screw mechanism selects kick-off (screw contained) or no kick-off (screw removed).

11. Faceplate

Stainless steel face plate supplied in square end (standard) and optional round end.

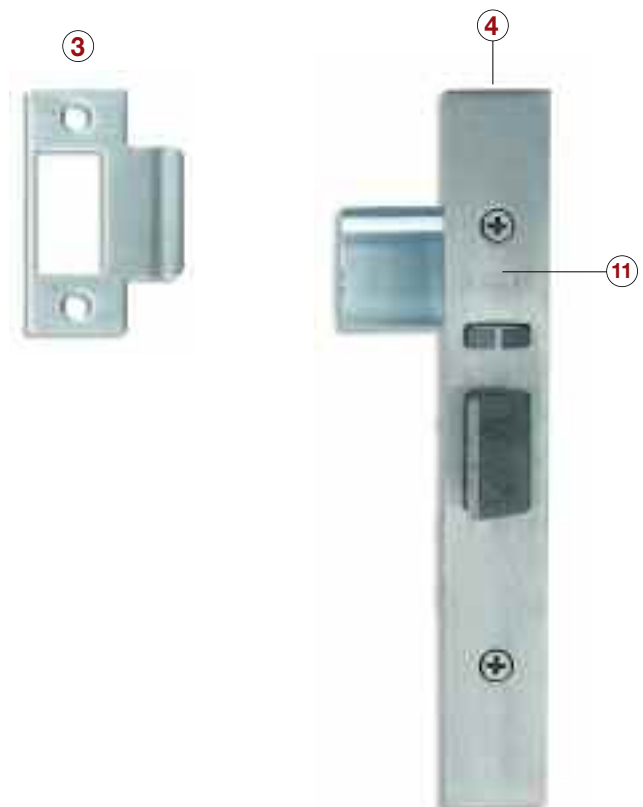
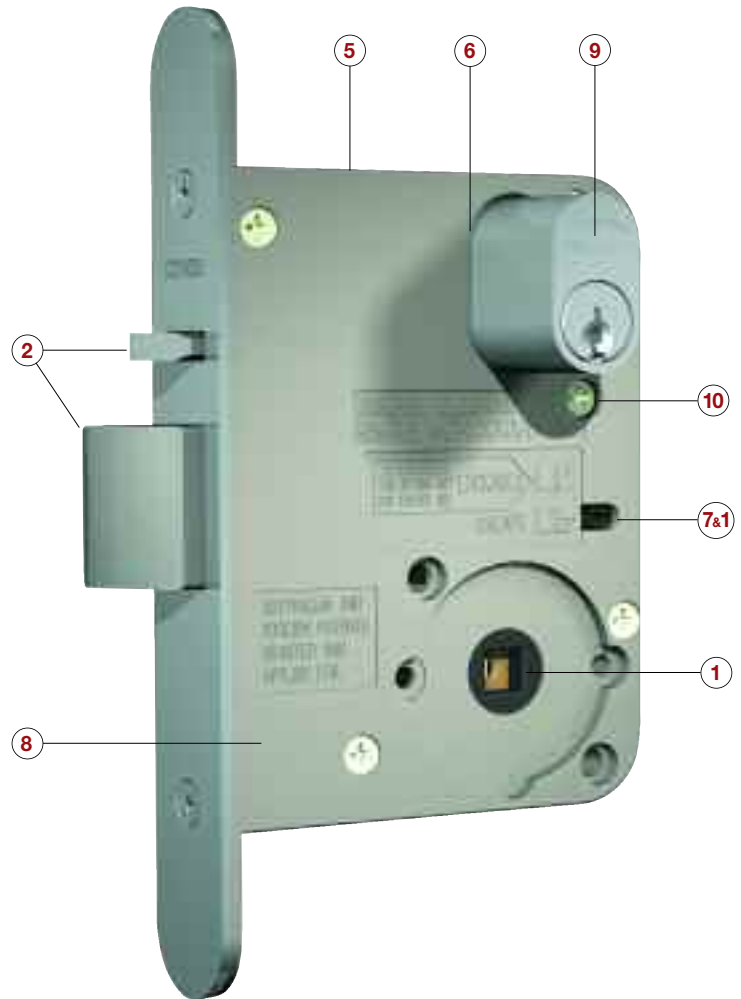

Cylinder Mortice Locks

3570 Series Ordering Procedure

| 3 | | 574 | | WT | | R | | SC | | #### | |
|---------|---|-------------------|-----|------------------------------|--------|---------|---|-------------------|----|---------------|---|
| Backset | | Functions | | Sub Function | | Handing | | Finish | | Options | |
| 60 mm | 3 | Nightlatch | 570 | eg. Outside | Inside | Right | R | Bright Chrome | CP | Modric spring | M |
| 89 mm | 4 | Deadlock | 571 | W | T | Left | L | Satin Chrome | SC | 8 mm hubs | 8 |
| 127 mm | 5 | Vestibule lock | 572 | Locking Cylinder with W cam | W | | | Florentine Bronze | FB | | |
| | | Sliding door lock | 573 | Latching Cylinder with X cam | X | | | Polished Brass | PB | | |
| | | Combination lock | 574 | Locking Cylinder with Y cam | Y | | | | | | |
| | | Dual entry lock | 577 | Locking Cylinder with Z cam | Z | | | | | | |
| | | Hold back lock | 578 | Locking Cylinder with M cam | M | | | | | | |
| | | | | Emergency button | E | | | | | | |
| | | | | Turnbutton adaptor | T | | | | | | |
| | | | | No sub function | - | | | | | | |
| | | | | Antilockout | A | | | | | | |

Code

1. Backset

Nominate backset as required, eg 3 = 60 mm backset.

2. Function

Select function, eg 572 = Vestibule Lock.

3. Sub Function

Determine sub function requirements for both exterior and interior, eg exterior – Locking function required – specify Z (cylinder).

Interior – turnknob function required – specify T (turnbutton adaptor).

4. Handing

If applicable refer to door handing chart to determine left or right hand, eg L.

5. Finish

Select appropriate finish, eg SC. Other finishes available on application.

6. Options

Where additional options are needed, specify as required. eg 8 mm hubs = 8.

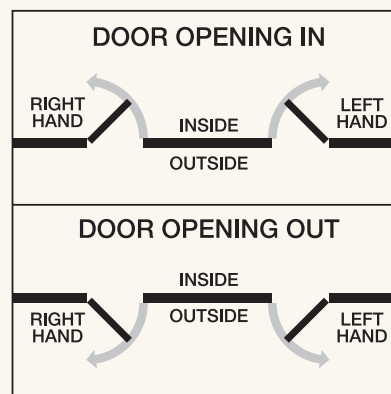

Cylinder Mortice Locks

3570 Nightlatches

Various latching functions operated by key outside and by turnknob or key inside. Locks automatically when door is closed. For all nightlatch functions specify primary lock eg 3570SC. This lock can then be easily adapted to suit function required.

Application

Cupboards, electrical, duct doors, risers, gates.

Features & Specifications

Bolt

Deadlatch only.

Keying

Can be keyed alike, master keyed, grand master keyed, maison keyed or construction keyed in Lockwood security keying systems.

Standard Finishes

- Bright Chrome CP
- Satin Chrome SC
- Florentine Bronze FB
- Polished Brass PB

Other finishes on application.

Ordering Procedure

Refer page 5.



Dimensions

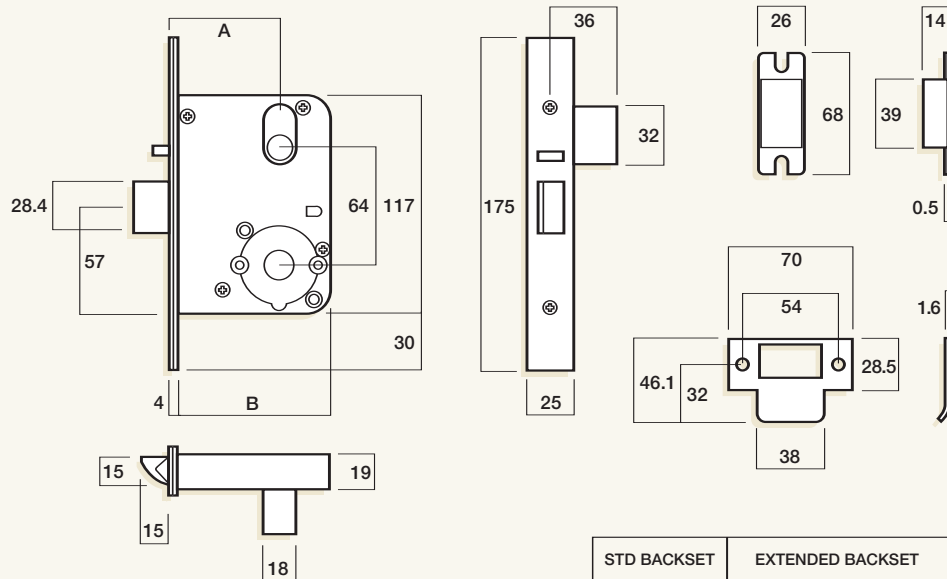

| | STD BACKSET | EXTENDED BACKSET | |
|-------------|-------------|------------------|-----|
| DIMENSION A | 60 | 89 | 127 |
| DIMENSION B | 84 | 113 | 151 |

Cylinder Mortice Locks

3570 Nightlatches

Nightlatch

Cylinder and turnknob. Reversible.

Right hand 3570XTR

Left hand 3570XTL

Outside: Opened by key.

Inside: Opened by turnknob.

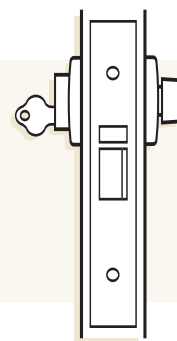

Communicating Door Latch

Double cylinder. Reversible.

Non handed 3570XX

Recommended for glass doors.

Outside: Opened by key.

Inside: Opened by key.

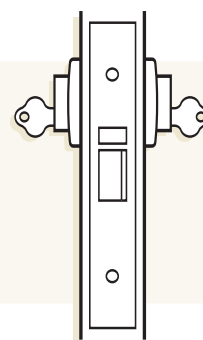

Exit Door Latch

Turnknob inside. Reversible.

Right hand 3570-TR

Left hand 3570-TL

Inside: Opened by turnknob.

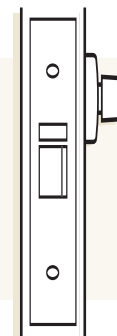

Cylinder Latch

Single cylinder. Reversible.

Right hand 3570X-R

Left hand 3570X-L

Lockset may be installed with cylinder either inside or outside.

Outside/Inside: Opened by key

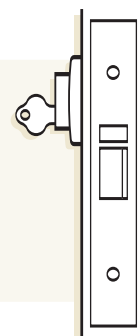

Cylinder Mortice Locks

3571 Deadlocks

Various deadlocking functions operated generally by key outside and by turnknob or key inside. Locked by key or turnknob when door is closed.

For all deadlock functions specify primary lock e.g. 3571SC. This lock can then be easily adapted to suit function required.

Application

Hospitality applications.

Features & Specifications

Bolt

19 mm stainless steel bolt.

Keying

Can be keyed alike, master keyed, grand master keyed, maison keyed or construction keyed in Lockwood security keying systems.

Standard Finishes

- Bright Chrome CP
- Satin Chrome SC
- Florentine Bronze FB
- Polished Brass PB

Other finishes on application.

Ordering Procedure

Refer page 5.



Dimensions

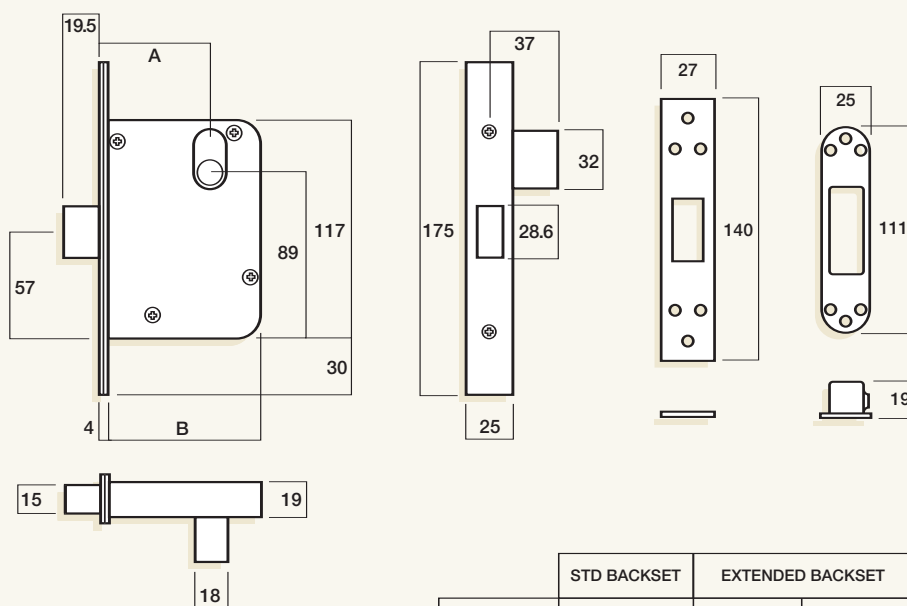

| | STD BACKSET | EXTENDED BACKSET | |
|-------------|-------------|------------------|-----|
| DIMENSION A | 60 | 89 | 127 |
| DIMENSION B | 84 | 113 | 151 |

Cylinder Mortice Locks

3571 Deadlocks

Deadlock

Cylinder and turnknob. Reversible.
3571WT

Outside: Locked or unlocked by key.
Inside: Locked or unlocked by turnknob.

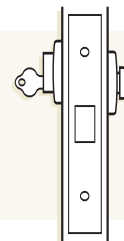

Glass Door Deadlock

Double cylinder. Reversible.
3571YY
Recommended for glass doors.

Outside: Locked or unlocked by key.
Inside: Locked or unlocked by key.

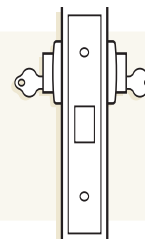

Exit Door Deadbolt

Turnknob inside. Reversible.
3571-T

Inside: Locked or unlocked by turnknob.

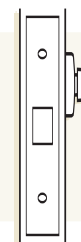

Lockup Shop Deadlock

Single cylinder. Reversible.
3571Y
Lockset may be installed with cylinder either inside or outside.

Outside/Inside: Locked or unlocked by key.

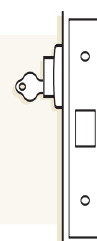

Escape Deadlock

Cylinder and escape lever.
Left hand 3571DEL
Right hand 3571DER

Outside: Locked or unlocked by key.
Inside: Unlocked only by escape turn.
Note: Specially machined lock case, cannot be made up from 3571 primary lock.

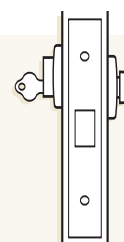

Through Fix Privacy Deadlock

Emergency Turn knob Escutcheon. Turn knob. Reversible.
3571PT

Outside: operated by coin or screwdriver in emergency situation by operating the slotted emergency turn button.
Inside: Locked or unlocked by turn knob.
Note: Furniture must be ordered separately.

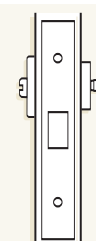

Cylinder Mortice Locks

3572 Vestibule Locks

Various latching functions operated generally by key or handle outside and by turnknob, key or handle inside.

These locks comply with building regulations for single-action escape doors.

For ease of selection specify primary lock eg 3572SC. This lock can then be easily adapted to suit function required.

Application

Office, storeroom, stairway, emergency egress doors, classroom doors.

Feature & Specifications

Bolt

Deadlatch only.

Keying

Can be keyed alike, master keyed, grand master keyed, maison keyed or construction keyed in Lockwood security keying systems.

Standard Finishes

Bright Chrome CP
 Satin Chrome SC
 Florentine Bronze FB
 Polished Brass PB
 Other finishes on application.

Ordering Procedure

Refer page 5.

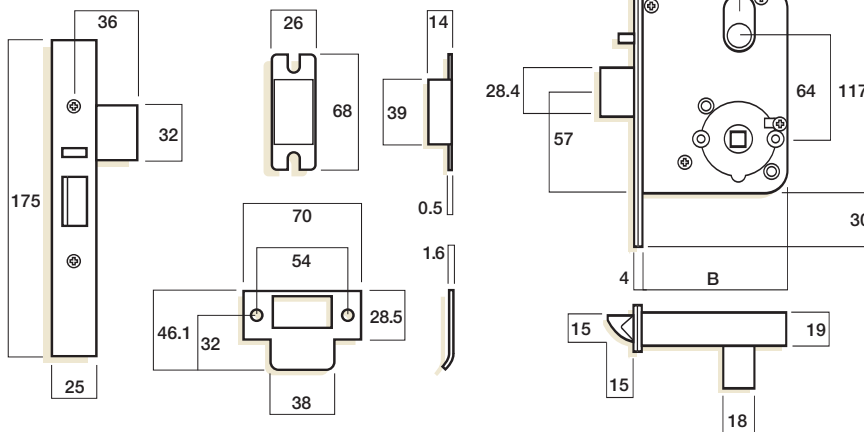

| | STD BACKSET | EXTENDED BACKSET | |
|-------------|-------------|------------------|-----|
| DIMENSION A | 60 | 89 | 127 |
| DIMENSION B | 84 | 113 | 151 |

Storeroom Locking Latch

Cylinder outside. Reversible.

Right hand 3572X-R
 Left hand 3572X-L

Outside: Opened by key. Handle is always rigid.
 Inside: Opened by handle at all times.

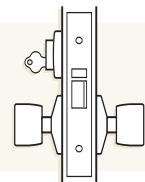

Single Action Escape Latch

Cylinder outside. Reversible.

Right hand 3572X-R
 Left hand 3572X-L

Outside: Opened by key.
 Inside: Opened by handle at all times.

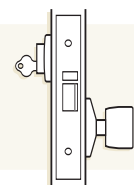

Classroom & Office Locking Latch

Cylinder outside. Reversible.

Right hand 3572Z-R
 Left hand 3572Z-L

Outside: Opened by handle except when handle is made inoperative by key from outside. Key locks or unlocks outside handle.
 Inside: Opened by handle at all times.

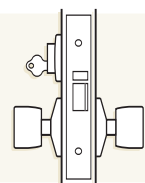

Antilockout Privacy Escape Latch

Emergency button and turn knob. Handed.

Right hand 3572EAR
 Left hand 3572EAL

Antilockout: Latching the bolt by key, closing the door or operation of inside handle will "kick-off" the locking feature, allowing the outside handle to become operative.

Outside: Opened by handle except when handle is made inoperative by turn knob from inside. Handle may be unlocked from outside by coin or screwdriver by operating the slotted emergency button.
 Inside: Opened by handle at all times. Turn knob locks or unlocks outside handle.

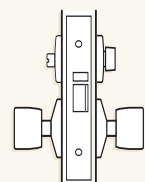

Cylinder Mortice Locks

3572 Vestibule Locks

Antilockout Entry Door Lock

Cylinder and turnknob. Handed.

Right hand 3572XAR

Left hand 3572XAL

Antilockout: Latching the bolt by key, closing the door or operation of inside handle will “kick-off” the locking feature, allowing the outside handle to become operative.

Outside: Opened by handle except when handle is made inoperative by key from outside or turnknob from inside. Key locks or unlocks outside handle.

Inside: Opened by handle at all times. Turnknob locks or unlocks outside handle.

Notes: a) Latchbolt can be retracted by key if handle has been rendered inoperative. b) Specially machined lock case, cannot be made up from 3572 primary lock.

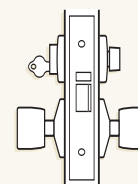

Classroom & Office Locking/Latching Latch

Locking/Latching cylinder outside. Handed.

Right hand 3572M-R

Left hand 3572M-L

Outside: Opened by handle except when handle is made inoperative by key from outside. Key locks or unlocks outside handle.

Inside: Open by handle at all times.

Note: Lock contains special adaptor to enable latch bolt to be retracted by key if handle has been rendered inoperative.

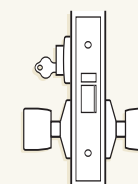

Antilockout Vestibule Set

Cylinder and turnknob. Handed.

Right hand 3572WAR

Left hand 3572WAL

Antilockout: Latching the bolt by key, closing the door or operation of inside handle will “kick-off” the locking feature, allowing the outside handle to become operative.

Outside: Opened by handle except when handle is made inoperative by key from outside or turnknob from inside. Key locks or unlocks outside handle.

Inside: Opened by handle at all times. Turnknob locks or unlocks outside handle.

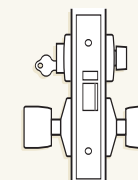

Vestibule Set

Cylinder and turnknob. Reversible.

Right hand 3572XTR

Left hand 3572XTL

Outside: Opened by key at all times. Opened by handle except when handle is made inoperative by turnknob from inside.

Inside: Opened by handle at all times. Turnknob locks or unlocks outside handle.

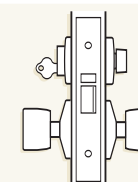

Exit Door Latch

Exit function only. Reversible.

Right hand 3572R

Left hand 3572L

Outside: Handle is always rigid.

Inside: Opened by handle at all times.

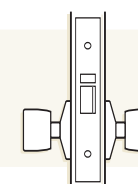

Exterior & Exit Door Lock

Double cylinder. Reversible.

Right hand 3572XZR

Left hand 3572XZL

Outside: Opened by key at all times. Opened by handle except when handle is made inoperative by key from inside.

Inside: Opened by handle at all times. Key locks or unlocks outside handle.

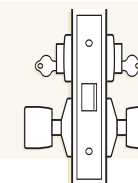

Exterior & Exit Door Lock

Cylinder inside. Reversible.

Right hand 3572-ZR

Left hand 3572-ZL

Outside: Opened by handle except when handle is made inoperative by key from inside.

Inside: Opened by handle at all times. Key locks or unlocks outside handle.

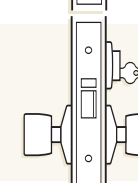

Exterior & Exit Door Lock

Turnknob inside. Reversible.

Right hand 3572-TR

Left hand 3572-TL

Outside: Opened by handle except when handle is made inoperative by turnknob from inside.

Inside: Opened by handle at all times. Turnknob locks or unlocks outside handle.

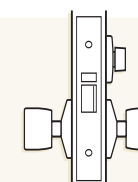

Cylinder Mortice Locks

3573 Sliding Door Deadlocks

Various deadlocking functions operated generally by key outside and by turnknob or key inside. Locked by key or turnknob when door is closed.

For all sliding door deadlock functions specify primary lock e.g. 3573SC. This lock can then be easily adapted to suit function required.

Application

Cavity sliding applications.

Features & Specifications

Bolt

Deadlock

Keying

Can be keyed alike, master keyed, grand master keyed, maison keyed or construction keyed in Lockwood security keying systems.

Standard Finishes

- Bright Chrome CP
- Satin Chrome SC
- Florentine Bronze FB
- Polished Brass PB
- Other finishes on application.

Ordering Procedure

Refer page 5.



Dimensions

| | STD BACKSET | EXTENDED BACKSET | |
|-------------|-------------|------------------|-----|
| DIMENSION A | 60 | 89 | 127 |
| DIMENSION B | 84 | 113 | 151 |

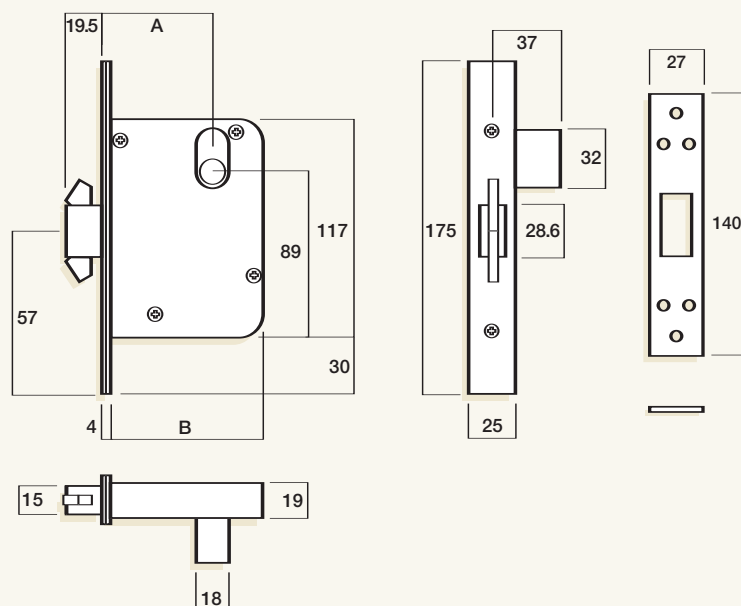

Cylinder Mortice Locks

3573 Sliding Door Deadlocks

Sliding Door Deadlock

Cylinder and turnknob. Reversible.

3573WT

Outside: Locked or unlocked by key.

Inside: Locked or unlocked by turnknob.

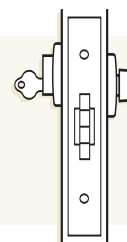

Sliding Glass Door Deadlock

Double cylinder. Reversible.

Recommended for glass doors.

3573YY

Outside: Locked or unlocked by key.

Inside: Locked or unlocked by key.

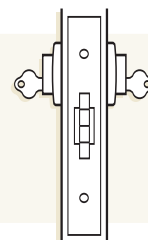

Exit Sliding Door Deadbolt

Turnknob inside. Reversible.

3573-T

Inside: Locked or unlocked by turnknob.

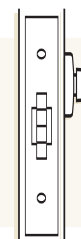

Lockup Shop Sliding Door Deadlock

Single cylinder. Reversible.

3573Y-

Lockset may be installed with cylinder either inside or outside.

Outside/Inside: Locked or unlocked by key.

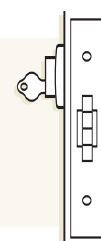

Sliding Door Escape Deadlock

Cylinder and escape lever.

3573DE

Outside: Locked or unlocked by key.

Inside: Unlocked only by escape turn.

Note: Specially machined lock case, cannot be made up from 3573 primary lock

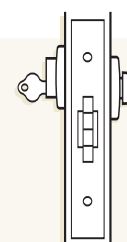

Sliding Door Through Fix Privacy Latch

Emergency Turn knob Escutcheon. Turn knob. Reversible.

3573PT

Outside: operated by coin or screwdriver in emergency situation by operating the slotted emergency turn button.

Inside: Locked or unlocked by turn knob.

Note: Furniture must be ordered separately.

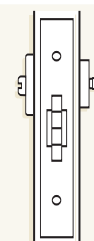

Cylinder Mortice Locks

3574 Combination Latches

Various latching functions operated generally by outside or inside handles, except when locked by key outside or by key or turnknob inside.

For ease of selection specify primary lock, eg 3572SC. This lock can then be easily adapted to function required.

Note: Passage set available with plainlatch only, eg 3574SC.

Applications

Office, privacy, passage, balcony.

Features & Specifications

Bolt

Deadlatch (plainlatch for passage latch).

Keying

Can be keyed alike, master keyed, grand master keyed, maison keyed or construction keyed in Lockwood security keying systems.

Standard Finishes

- Bright Chrome CP
- Satin Chrome SC
- Florentine Bronze FB
- Polished Brass PB

Other finishes on application.

Ordering Procedure

Refer page 5.

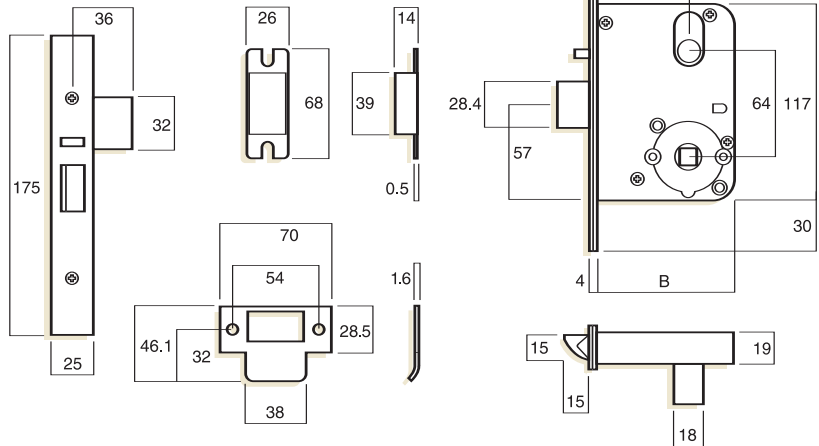

| DIMENSION | STD BACKSET | | EXTENDED BACKSET | |
|-------------|-------------|-----|------------------|--|
| | 60 | 89 | 127 | |
| DIMENSION A | 60 | 89 | 127 | |
| DIMENSION B | 84 | 113 | 151 | |

Office Locking Latch

Cylinder and turnknob. Reversible.

| | |
|------------|---------|
| Right hand | 3574WTR |
| Left hand | 3574WTL |

Outside: Opened by handle except when handle is made inoperative by key from outside or by turnknob from inside. Key locks or unlocks both handles.

Inside: Opened by handle except when handle is made inoperative by key from outside or turnknob from inside. Turnknob locks or unlocks both handles.

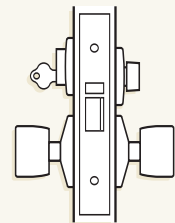

Glass Door Locking Latch

Double cylinder. Non-handed.

3574ZZ

Outside: Opened by handle except when handle is made inoperative by key from either side. Key from either side locks or unlocks both handles.

Inside: Opened by handle except when handle is made inoperative by key from either side. Key from either side locks or unlocks both handles.

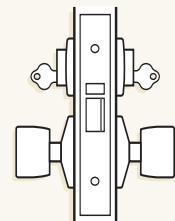

Cylinder Mortice Locks

3574 Combination Latches

Glass Door Locking Latch

Cylinder outside. Reversible.

Right hand 3574Z-R

Left hand 3574Z-L

Outside: Opened by handle except when handle is made inoperative by key from outside. Key locks or unlocks both handles.

Inside: Opened by handle except when handle is made inoperative by key from outside.

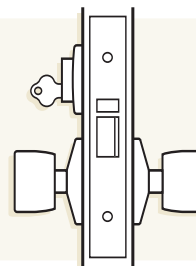

Passage Latch

No locking function. Reversible.

3574

Plainlatch only.

Outside: Opened by handle.

Inside: Opened by handle.

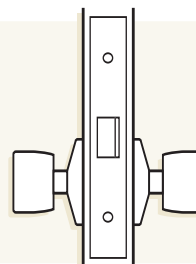

Privacy Latch

Emergency button and turnknob. Reversible.

Right hand 3574ETR

Left hand 3574ETL

Outside: Opened by handle except when handle is made inoperative by turnknob from inside. Handle may be unlocked from outside by coin or screwdriver by operating the slotted emergency turnbutton.

Inside: Opened by handle except when handle is made inoperative by turnknob. Turnknob locks or unlocks both handles.

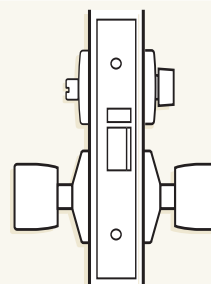

Knob Locking Latch

Cylinder and turnknob. Reversible.

Right hand 3574ZTR

Left hand 3574ZTL

Outside: Opened by handle except when handle is made inoperative by key from outside. Key locks or unlocks both handles.

Inside: Opened by turnknob at all times. Opened by handle except when handle is made inoperative by key from outside.

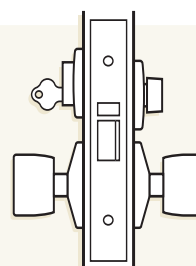

Glass Door Locking Latch

Double cylinder. Reversible.

Right hand 3574XZR

Left hand 3574XZL

Outside: Opened by key at all times. Opened by handle except when handle is made inoperative by key from inside.

Inside: Opened by handle except when handle is made inoperative by key from inside. Key locks or unlocks both handles.

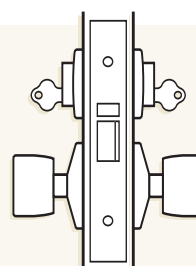

Cylinder Mortice Locks

3577 Dual Entry Deadlatch

Designed to enable emergency services to enter specific areas without giving access to all locksets in the building and the ability to lockout keys with restricted access at certain times.

Features & Specifications

Furniture

Select from Lockwood 1800, 2800, aluminium or stainless steel ranges.

Keying

Can be keyed alike, master keyed, grand master keyed, maison keyed or construction keyed in Lockwood security keying systems.

Standard Finishes

| | |
|-------------------|----|
| Bright Chrome | CP |
| Satin Chrome | SC |
| Florentine Bronze | FB |
| Polished Brass | PB |

Ordering Procedure

Refer page 5.

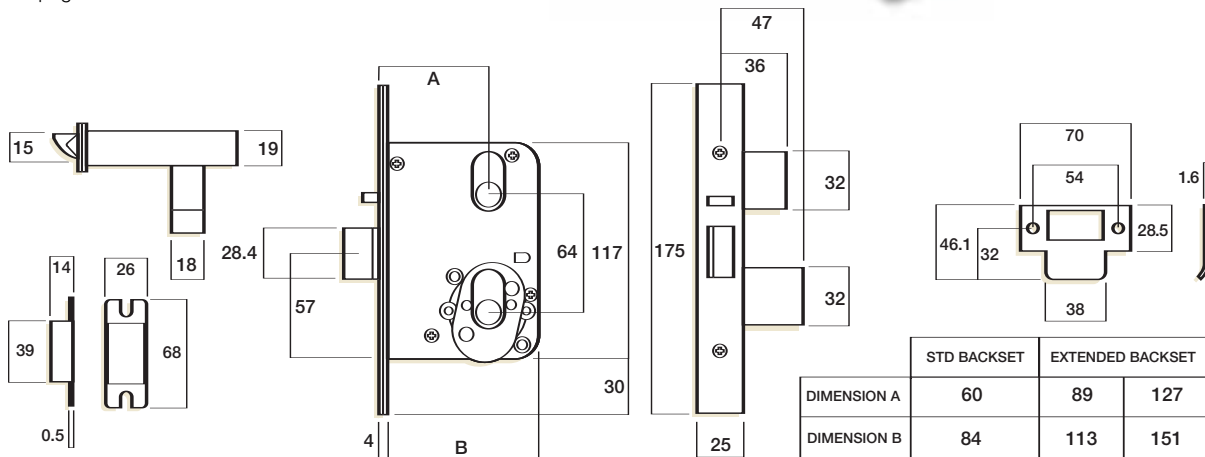

Dual Entry Deadlatch

Two cylinders outside.

Handle inside. Handed.

Right hand 3577X-R

Left hand 3577X-L

Outside: Opened by key, cylinders are keyed to differ.

Inside: Opened by handle at all times.

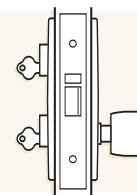

Dual Entry/Key Lockout Deadlatch

Two cylinders outside.

Handle inside. Handed.

Right hand 3577Z-R

Left hand 3577Z-L

Outside: Opened by bottom key. Top key locks or unlocks bottom key.

Inside: Opened by handle at all times.

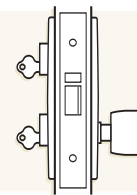

Dual Entry/Key Lockout Latching Latch

Two cylinders outside.

Handle inside. Handed.

Right hand 3577M-R

Left hand 3577M-L

Outside: Opened by bottom key when unlocked by top key. Top key locks or unlocks bottom key and retracts latch.

Inside: Opened by handle at all times.

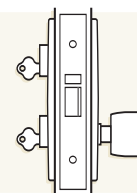

Cylinder Mortice Locks

3578 Hold Back Deadlatches

A deadlatching lockset developed for applications where latch hold back is required, e.g. high use doors and toilet doors.

Features & Specifications

Bolt

Deadlatch

Keying

Can be keyed alike, master keyed, grand master keyed, maison keyed or construction keyed in Lockwood security keying systems.

Fire Rating

3578 Hold Back deadlatches are non-fire rated.

Standard Finishes

| | |
|--------------------------------|----|
| Bright Chrome | CP |
| Satin Chrome | SC |
| Florentine Bronze | FB |
| Polished Brass | PB |
| Other finishes on application. | |

Ordering Procedure

Refer page 5.

| | STD BACKSET | EXTENDED BACKSET | |
|--------------------|-------------|------------------|-----|
| DIMENSION A | 60 | 89 | 127 |
| DIMENSION B | 84 | 113 | 151 |

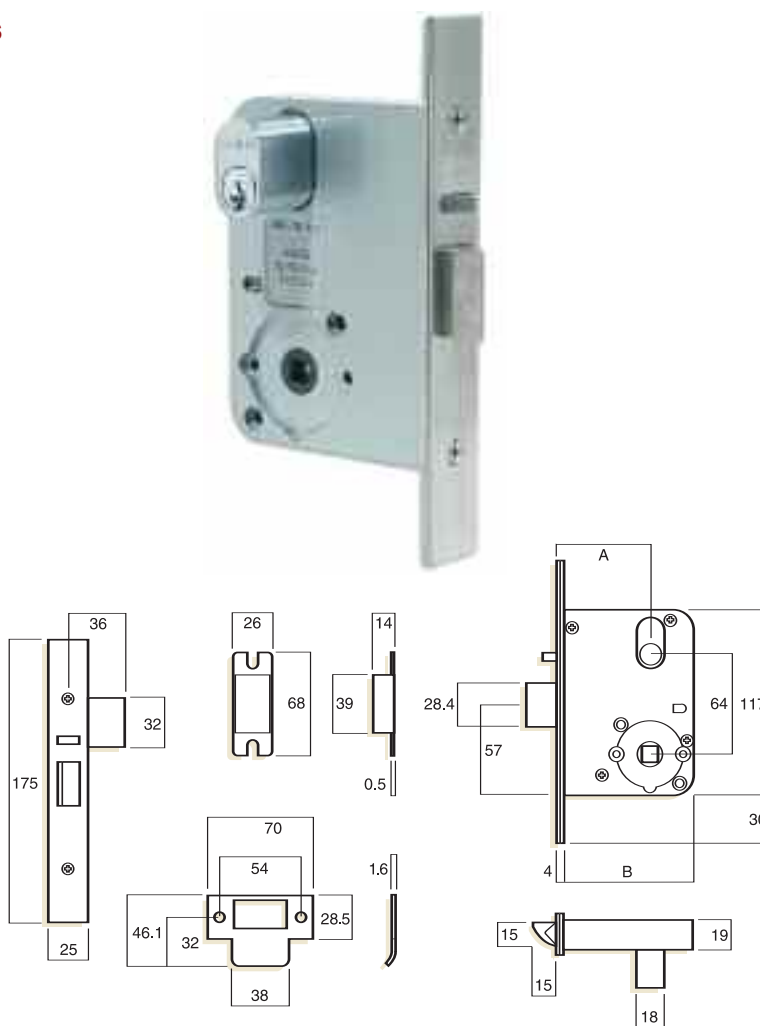

Classroom & Office Locking/Latching Latch with Hold Back

Cylinder outside. Reversible.

| | |
|------------|---------|
| Right hand | 3578Z-R |
| Left hand | 3578Z-L |

Outside: Opened by handle except when handle is made inoperative by key from outside. Key locks or unlocks outside handle.

Inside: Open by handle at all times.

Hold Back: Latchbolt held back when latch depressed and key rotated 360°.

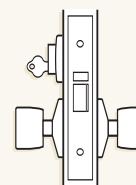

Antilockout Vestibule Set

Cylinder and turnknob. Handed.

| | |
|------------|---------|
| Right hand | 3578WTR |
| Left hand | 3578WTL |

Outside: Opened by handle except when handle is made inoperative by key from outside or turnknob from inside. Key locks or unlocks outside handle.

Inside: Opened by handle at all times. Turnknob locks or unlocks outside handle.

Hold Back: Latchbolt held back when latch depressed and key or turnsnib rotated 90°.

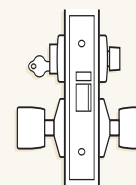

Classroom & Office Locking Latch

Cylinder outside. Reversible.

| | |
|------------|---------|
| Right hand | 3578M-R |
| Left hand | 3578M-L |

Note: Lock contains special adaptor to enable latch bolt to be retracted by key if handle has been rendered inoperative.

Outside: Opened by handle except when handle is made inoperative by key from outside. Key locks or unlocks outside handle.

Inside: Opened by handle at all times.

Hold Back: Latchbolt held back when latch depressed and key rotated 90°.

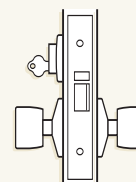

Cylinder Mortice Locks

3570 Series Accessories

Brass Angle Strike

Wall mounted strike for use with 3571 functions to enable door to be held in the open position.

Part No.

| | |
|-------------------|----------|
| Bright Chrome | 213-53CP |
| Polished Brass | 213-53PB |
| Satin Chrome | 213-53SC |
| Florentine Bronze | 213-53FB |

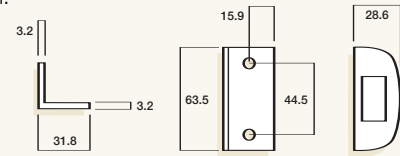

Short/Extended Lipped Strikes

Standard finishes

| | |
|---|-----|
| Bright Chrome | CP |
| Satin Stainless Steel | SSS |
| Florentine Bronze | FB |
| Polished Brass | PB |
| To order, add finish code to part number. | |

| Finish | "A" | Part No. |
|------------|---------|-------------|
| SSS, | 25.4 mm | SP3570-4053 |
| CP, FB, PB | 25.4 mm | SP3570-4153 |
| SSS, | 32 mm | SP3570-5053 |
| CP, FB, PB | 32 mm | SP3570-5153 |
| SSS | 43.5 mm | SP3570-5253 |
| CP, FB, PB | 43.5 mm | SP3570-5353 |
| SSS | 47.5 mm | SP3570-5453 |
| CP, FB, PB | 47.5 mm | SP3570-5653 |

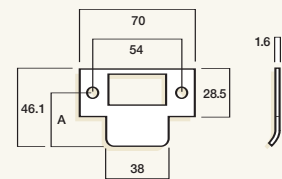

Latching Strike

Alternative strike for use with 3573 functions to allow door to latch when bolt is projected.

Part No.

| | |
|-------------------|---------------|
| Bright Chrome | SP3573-5053CP |
| Satin Chrome | SP3573-5053SC |
| Florentine Bronze | SP3573-5053FB |
| Polished Brass | SP3573-5053PB |

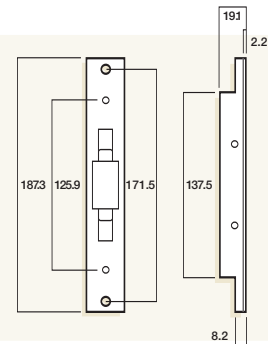

Rebate Kits

Rebate kits to suit standard 13 mm rebate.

Latch Rebate Kits

(3570, 3572, 3574, 3577, 3578)

To order, add finish to part number.

Standard finishes

| | |
|-------------------|----|
| Bright Chrome | CP |
| Satin Chrome | SC |
| Florentine Bronze | FB |
| Polished Brass | PB |

Deadlock Rebate Kits (3571/3573)

Rebate kit part No. 3571 - 2902

To order, add finish to part number.

Standard finishes

| | |
|-------------------|----|
| Bright Chrome | CP |
| Satin Chrome | SC |
| Florentine Bronze | FB |
| Polished Brass | PB |

| Lip length | Rebate kit part No. |
|------------|---------------------|
| 32 | 3570-2902 |
| 46 | 3570-3902 |

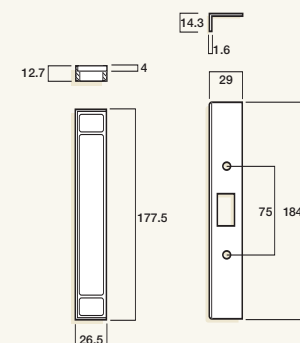
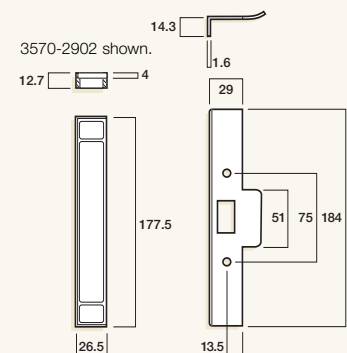

Cylinder Mortice Locks

3570 Accessories

Round Cylinders

Round cylinders designed to complement round rose door furniture.

Part No.

| | |
|-------------------|-----------|
| Bright Chrome | 570-637CP |
| Satin Chrome | 570-637SC |
| Florentine Bronze | 570-637FB |
| Polished Brass | 570-637PB |

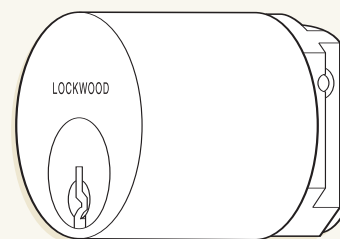

Hold Back Cylinder

For use with 3570 locks only.

Special latching cylinders with levers that enable the latchbolt to be held in retracted position. This cylinder type hold back can only be applied or released by the key. These special latching cylinders are available on application and are supplied ex-factory handed to suit lock function.

To apply Hold Back: Insert key into cylinder and retract bolt with one full turn of key. Hold bolt depressed with finger and withdraw key.

To release Hold Back: Insert key into cylinder, rotate key one full turn and withdraw key.

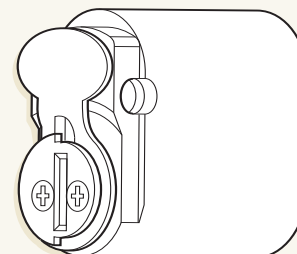

| Right hand | Part No. | Left hand | Part No. |
|-------------------|-------------|-------------------|-------------|
| Bright Chrome | 3570-2402CP | Bright Chrome | 3570-2452CP |
| Satin Chrome | 3570-2402SC | Satin Chrome | 3570-2452SC |
| Florentine Bronze | 3570-2402FB | Florentine Bronze | 3570-2452FB |
| Polished Brass | 3570-2402PB | Polished Brass | 3570-2452PB |

Extended Cylinders

Extended cylinders should be considered when door thickness exceeds 50 mm or when the lock is mounted off centre in the door edge. A range of cylinders is available to suit various door thicknesses.

Standard finishes

| | |
|-------------------|----|
| Bright Chrome | CP |
| Satin Chrome | SC |
| Florentine Bronze | FB |
| Polished Brass | PB |

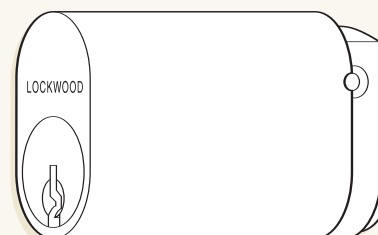
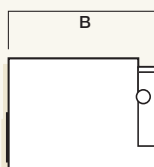

Part Number with Relevant Cam

| "X" Cam | "Z" Cam | "W" Cam | "A" Cylinder Projection | "B" Cylinder Length | Door Thickness (lock central) |
|----------|----------|----------|-------------------------|---------------------|-------------------------------|
| 570-2/37 | 572-2/37 | 575-2/37 | 42 | 39 | 50 to 58 |
| 570-2/48 | 572-2/48 | 575-2/48 | 53 | 50 | 58 to 82 |
| 570-2/60 | 572-2/60 | 575-2/60 | 65 | 62 | 82 to 106 |
| 570-2/76 | 572-2/76 | 575-2/76 | 81 | 78 | 106 to 130 |
| 570-2/84 | 572-2/84 | 575-2/84 | 89 | 86 | 130 to 154 |
| 570-2/98 | 572-2/98 | 575-2/98 | 103 | 100 | 154 to 178 |

A = Cylinder in mounted position to the outside of cylinder face.

B = Overall cylinder length excluding cam.

Cylinder Mortice Locks

3570 Cylinder/Cam & Adaptors Chart

Single Cylinder Assemblies

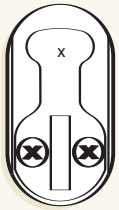

"X" CAM
570-2

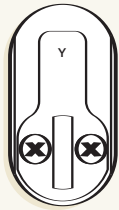

"Y" CAM
571-2



"Z" CAM
572-2



"W" CAM
575-2



"M" CAM
575-52

Double Cylinder Assemblies

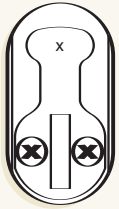

"X" CAMS
570-701

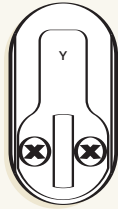
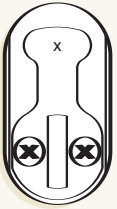

"Y" CAMS
571-701

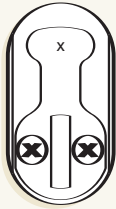
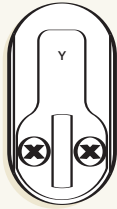

"X" CAM AND "Z" CAM
574-701



"Z" CAMS
575-701



Adaptors

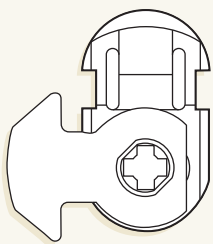

SP3570-5050

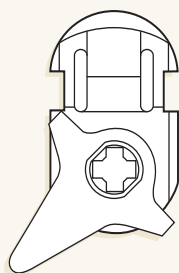

SP3571-5050

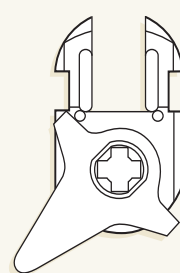

SP3571-6050

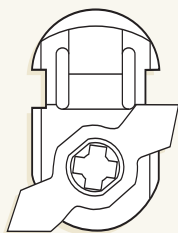

SP3572-5250

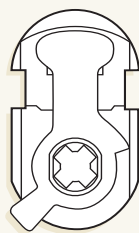

SP3572-5350
(RH)

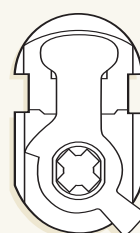

SP3572-5450
(LH)

Cylinder Mortice Locks

3570 Cam/Adaptor Function Chart

| | Cam/Adaptor Outside | Cam/Adaptor Inside |
|----------|------------------------------------|----------------------------------|
| 3570 | - | - |
| 3570-T | - | SP3570-5050 |
| 3570X- | X | - |
| 3570XT | X | SP3570-5050 |
| 3570XX | X | X |
| 3571 | - | - |
| 3571DE# | Y | SP3571-6050 |
| 3571-T | - | SP3571-5050 |
| 3571Y | Y | - |
| 3571WT | W | SP3571-5050 |
| 3571YY | Y | Y |
| 3571PT | - | SP3571-5050 |
| 3572 | - | - |
| 3572X- | X | - |
| 3572Z- | Z | - |
| 3572EA* | - | SP3572-5250 |
| 3572XA#* | X | SP3572-5250 |
| 3572M- | M | SP3572-5350(RH), SP3572-5450(LH) |
| 3572WA* | W | SP3572-5250 |
| 3572XT | X | SP3572-5250 |
| 3572XZ | X | Z |
| 3572-Z | - | Z |
| 3572-T | - | SP3572-5250 |
| 3573 | - | - |
| 3573DE# | Y | SP3571-6050 |
| 3573-T | - | SP3571-5050 |
| 3573Y | Y | - |
| 3573WT | W | SP3571-5050 |
| 3573YY | Y | Y |
| 3573PT | - | SP3571-5050 |
| 3574WT | W | SP3572-5250 |
| 3574ZZ | Z | Z |
| 3574Z- | Z | - |
| 3574 | - | - |
| 3574EA* | - | SP3572-5250 |
| 3574ET | - | SP3572-5250 |
| 3574ZT | Z | SP3570-5050 |
| 3574XZ | X | Z |
| 3577X | X (TOP CYL) + 577-302 (BOTTOM CYL) | - |
| 3577Z | Z (TOP CYL) + 577-302 (BOTTOM CYL) | - |
| 3577M | M (TOP CYL) + 577-302 (BOTTOM CYL) | SP3572-5350(RH), SP3572-5450(LH) |
| 3578 | - | - |
| 3578WT | W | SP3572-5250 |
| 3578Z- | Z | - |
| 3578M- | M | SP3572-5350(RH), SP3572-5450(LH) |

*Includes kick-off

#Specially machined lock case



LOCK UP WITH LOCKWOOD®

Visit us at: www.assaabloypacific.com

ASSA ABLOY Sales Offices & Authorised Agents in Asia Pacific

Sales Offices - Australia

Victoria – Head Office

50 Edward Street
Oakleigh VIC 3166
Telephone (03) 8574 3888
Facsimile (03) 8574 3788

Queensland South

450 Sherwood Road
Sherwood QLD 4075
Telephone (07) 3373 5200
Facsimile (07) 3373 5256

Queensland North

Ralph Buck Agencies
15 Mackley Street
Garbutt QLD 4814
Telephone (07) 4779 0177
Facsimile (07) 4775 1480

New South Wales – Commercial

Unit 1/16 Atkinson Road
Taren Point NSW 2229
Telephone (02) 8543 3700
Facsimile (02) 9531 7944

New South Wales – Residential

Unit 5/30 Foundry Road
Seven Hills NSW 2147
Telephone (02) 9624 2666
Facsimile (02) 9620 9340

Abloy Security

5/372 Eastern Valley Way
Chatswood NSW 2067
Telephone (02) 9882 6066

South Australia

182 Magill Road
Norwood SA 5067
Telephone (08) 8139 0403
Facsimile (08) 8364 1975

Western Australia

45 Gladstone Street
East Perth WA 6004
Telephone (08) 9227 9588
Facsimile (08) 9227 8913

Tasmania

23 Antill Street
South Hobart TAS 7000
Telephone (03) 6223 5404
Facsimile (03) 6224 0435

Sales Offices - New Zealand

Auckland – Commercial

10 Haultain Street, Eden Terrace
Auckland, New Zealand
Telephone +64 (0)9 634 5590
Facsimile +64 (0)9 634 5589

Auckland – Residential

6 Armstrong Road
North Harbour Industrial Estate
Albany, Auckland, New Zealand
Telephone +64 (0)9 415 7111
Facsimile +64 (0)9 415 7222

Christchurch

112 Wordsworth Street, Sydenham
Christchurch, New Zealand
Telephone +64 (0)3 348 2294
Facsimile +64 (0)3 379 4819

Wellington

Display Centre, Level 3,
10 Hutt Road, Petone
Wellington, New Zealand
Telephone +64 (0)4 913 4214
Facsimile +64 (0)4 913 4213

Manufacturing Plants

Victoria

50 Edward Street
Oakleigh VIC 3166
Telephone (03) 8574 3888
Facsimile (03) 8574 3788

Queensland

450 Sherwood Road
Sherwood QLD 4075
Telephone (07) 3373 5200
Facsimile (07) 3373 5256

New Zealand

6 Armstrong Road
North Harbour Industrial Estate
Albany, Auckland New Zealand
Telephone +64 (0)9 415 7111
Facsimile +64 (0)9 415 7222



Export Department

50 Edward Street
Oakleigh VIC 3166 Australia
Telephone +61 (0)3 8574 3888
Facsimile +61 (0)3 8574 3789

Asian Offices

ASSA ABLOY – Malaysia

ASSA ABLOY – Singapore

ASSA ABLOY – Thailand

ASSA ABLOY – Hong Kong

ASSA ABLOY – Shanghai

ASSA ABLOY – Beijing

ASSA ABLOY – Korea

Contact the Export Department,
Australia for details.

Worldwide Distributors

Contact the Export Department,
Australia for details.

ASSA ABLOY

Lockwood Guarantee

ASSA ABLOY Australia Pty Limited ("ASSA ABLOY") guarantees its Lockwood products against defects in workmanship and materials. If within the normal working life of a product it is found to be defective, ASSA ABLOY will supply the same or equivalent product free of charge.

All electrical and electronic components used in ASSA ABLOY's range of products excluding batteries are guaranteed for a period of 12 months from the date of proof of purchase, unless stated otherwise.

ASSA ABLOY assumes no liability under the guarantee for the following:

1. Improper installation or failure to follow fitting instructions.
2. Failure due to improper maintenance.
3. Failure due to fair wear and tear.
4. Indirect or consequential loss or damage.
5. Cost of removal and/or replacement.

6. Cost of freight and/or travelling time.

7. The plated finishes Florentine Bronze, Architectural Bronze, Polished Brass, Gold and Satin Brass, "which" are classified as soft finishes. As deterioration is possible under some environmental conditions, these finishes are excluded from this guarantee.

8. Any modification or repairs to a product, as supplied, unless authorised by ASSA ABLOY Australia Pty Limited.

9. Use of replacement parts other than authorised parts.

10. Malfunction or failure of the product due to the use of non-genuine Lockwood parts.

11. Malfunction or failure of the product due to the use of non-specified batteries.

Nothing in the ASSA ABLOY Australia Pty Limited guarantee excludes, restricts or modifies any condition, warranty, right or liability implied or protected by law where to do so would render the Guarantee, or any part of it, void.

