

LOCKWOOD

Daintree[®] Series

Door Furniture

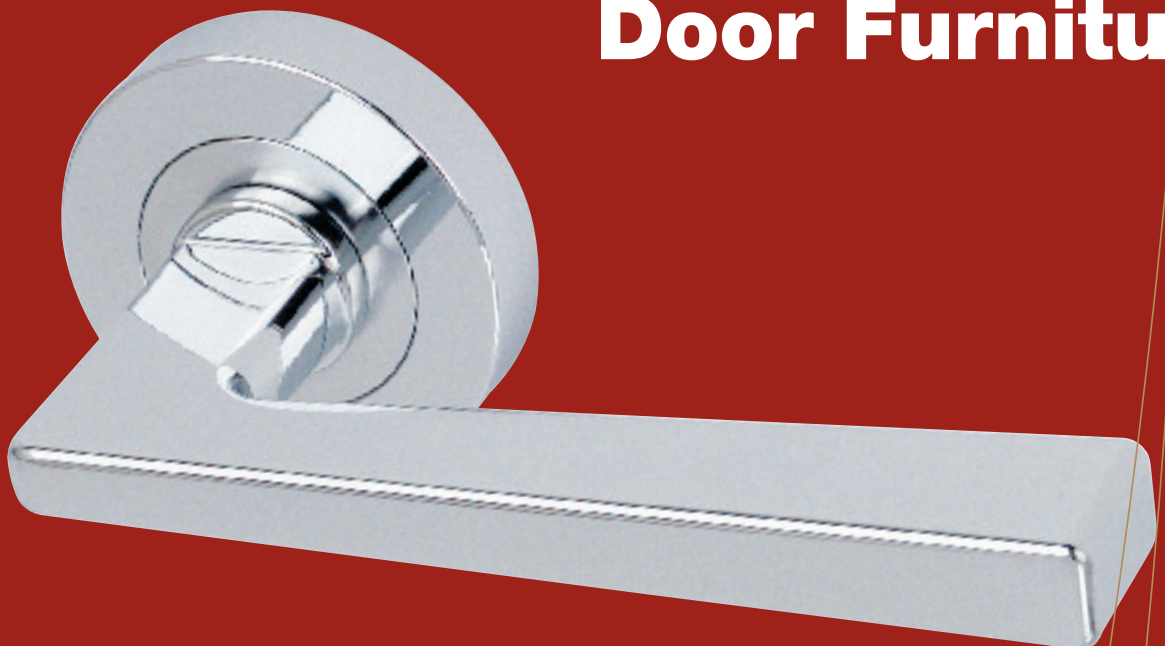

Daintree® Series Door Furniture

The outstanding range of Daintree door furniture offers architects, specifiers and interior designers an array of levers that can be used in semi-commercial or residential environments.

Designed in Australia the Daintree series of door furniture reflects the best in quality combined with cultured designs.

The Daintree series was produced to meet the stringent aesthetic requirements of the residential markets, while conforming to the ever increasing need for quality in the semi-commercial building segments.



Hakea™ #28



Acacia™ #29



Lilly® #31



Banksia™ #33



Saltbush® #34



Spinifex® #35



Mulga® #36



Gidgee® #37

Daintree® Series Door Furniture

Contents

Description	Page
Daintree General Information	4
Daintree Door Furniture Ordering Procedure	5
Daintree Escutcheons Ordering Procedure	5
Daintree 3680 Square Series & 3880 Round Series Door Furniture	6 – 7
Daintree Lever Furniture	8 – 9
Daintree 3680 Square Series Cylinders & Turn Escutcheons	10
Daintree Square Series Accessories	11
Daintree 3880 Round Series Cylinders & Turn Escutcheons	12
Daintree Round Series Accessories	13
Daintree Accessories	14
Daintree Privacy Adaptors	15

Specification Service

For all Architectural hardware specification assistance refer to your local ASSA ABLOY Sales Office.

A fully comprehensive, obligation free, Architectural Door Hardware specification can be prepared by Architectural Hardware Representatives.

Cleaning

Care should be taken during construction/refurbishment to ensure that paint, thinners, mortar or cement splashes are carefully removed from locks, furniture and hardware. Removal of these splashes with strong cleaning agents or scourers should be avoided.

Dirt and grime should be regularly removed with a soft damp cloth. A solution of mild soap and water may be required. During cleaning, care should be taken to prevent cleaning solution from entering the cylinder keyway. Surfaces should be dried and possibly lubricated.

Lubrication

During assembly of the furniture, the areas of contact of the internal mechanism which require lubrication are given an application of high quality grease. Where an installation is exposed to temperature extremes, a dusty or dirty environment, or such that the original lubricant becomes contaminated resulting in unsatisfactory operation, then the mechanism should be cleaned with a non-corrosive solvent and re-lubricated.

Quality Endorsed Company



The Standards Association of Australia operates a program which assesses the quality procedures and capabilities of an organisation in terms of the requirements of specific Australian and International Standards for

Supplier's Quality Systems.

Following assessment by the Standards Association of Australia, ASSA ABLOY Australia Pty Limited 50 Edward Street, Oakleigh VIC 3166 have been granted a certificate of registration as an approved supplier in the associations supplier Assessment Scheme to AS 3902/ISO 9001 - Quality Systems for Production and Installation.

Disclaimer

Whilst every effort has been made to ensure that the information contained in this catalogue is accurate at the time of publication, Lockwood recommends that you consult Lockwood or its agents prior to placing an order to ascertain current information on specific products, as Lockwood reserves the right to make changes without notice. Lockwood will not be liable for any injury, loss or damage whatsoever, arising from any errors or omissions in the information contained in the catalogue or arising from the use or application of the information contained herein. This catalogue does not constitute an offer for the sale of any particular product.

Daintree® Series Door Furniture

Daintree Door Furniture Ordering Procedure

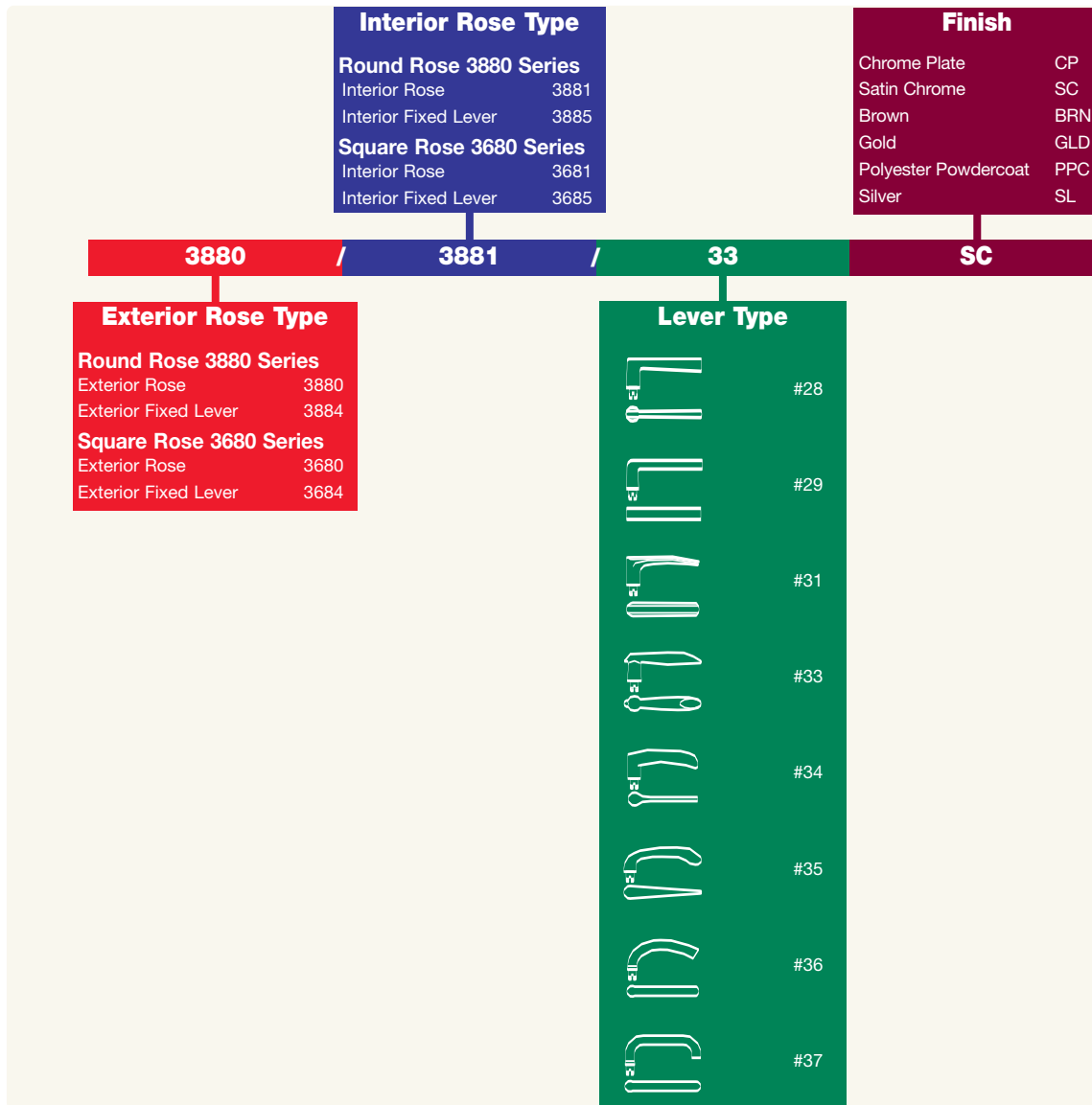

Escutcheons Ordering Procedure



Daintree® Series Door Furniture

Daintree 3680 Square Series & 3880 Round Series Door Furniture

Description:

Lockwood Daintree furniture is available in the traditional and classy round rose version as well as a modern and stylish square rose series. All square roses feature locating lugs that ensure perfect alignment on doors.

Application:

A range of high quality levers suitable for use in residential buildings and semi commercial applications.

Designed and manufactured in Australia for use with Lockwood Synergy 3570 Series mortice locks and A5250 tubular latch.

Door Thickness:

- 33 mm minimum for A5250 latches.
- 32 mm minimum for Lockwood 3570 Series mortice locks.
- Maximum door thickness 45 mm.
- Longer screws and spindles available upon application.

Fixing:

Roses are designed to fit back to back and fixing points are concealed. The Daintree mechanism incorporates a lever handle torsion spring which provides a positive feel and increased product life. All lever handles are reversible.

Rose Dimensions:

Round Rose: 55 mm diameter x 12.5 mm.

Square Rose: 57 mm x 57 mm x 12.5 mm.

Materials:

Zinc die-cast

Standard Finishes:

Brown	(BRN)
Chrome Plate	(CP)
Gold	(GLD)
Polyester Powdercoat	(PPC)
Satin Chrome	(SC)
Silver	(SL)

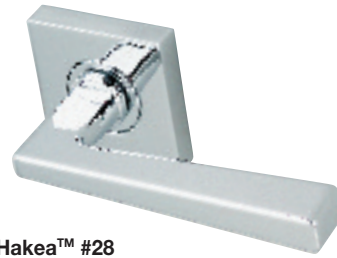

Hakea™ #28

**Design Registration pending in Australia/New Zealand*



Acacia™ #29

**Design Registration pending in Australia/New Zealand*

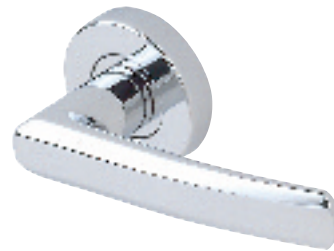

Lilly® #31

**Design Registered Australia/New Zealand*



Banksia™ #33

**Design Registered Australia/New Zealand*

Daintree 3680 Series & 3880 Series Rose & Lever Selection Chart

Levers

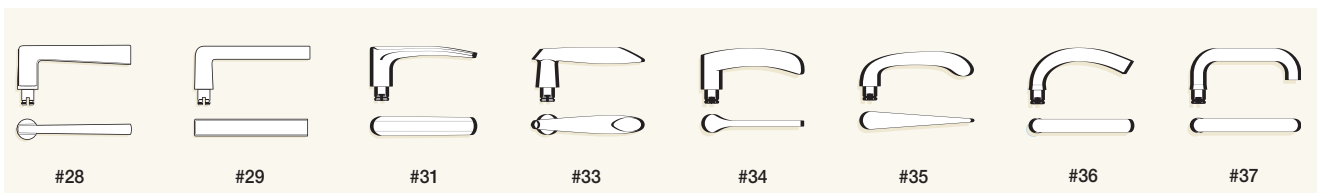

Roses (Round)

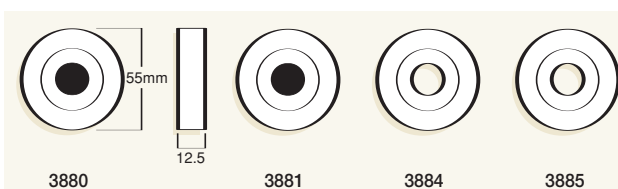

Roses (Square)

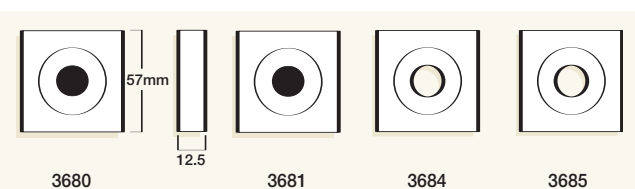

Daintree® Series Door Furniture

Daintree 3680 Square Series & 3880 Round Series Door Furniture



Saltbush® #34

Handing:

A removable stop screw allows all symmetrically designed levers to be handed on site.

Fire Rating:



Daintree Door Furniture has been successfully fire rated up to four hours on fire door assemblies in accordance with Australian Standard AS 1905.1-1997. Part 1: Fire-resistant doorsets.



Spinifex® #35

**Design Registered Australia/New Zealand*

Security:



All Daintree Door Furniture conforms with level S2 (Physical Security) Australian Lock Standard (Standard Number AS 4145.2-1993.)

Durability:



All Daintree Door Furniture conforms with level D2 (Durability) Australian Lock Standard (Standard Number AS 4145.2-1993.)



Mulga® #36



Gidgee® #37

Daintree 3680 Series & 3880 Series Cylinder & Turn Escutcheon Selection Chart

Cylinder and Turn Escutcheons

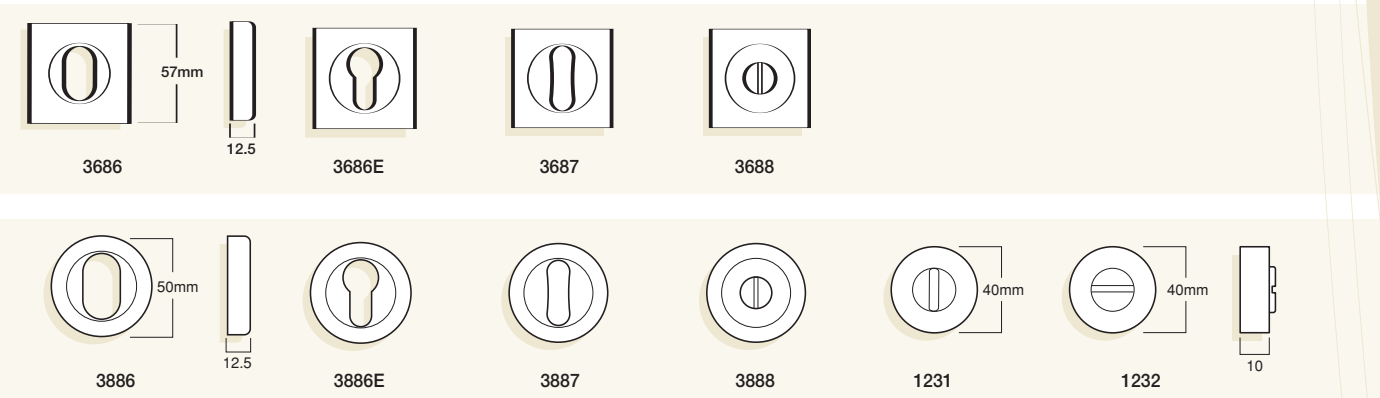

Daintree® Series Door Furniture

Daintree Lever Furniture

Daintree Lever Designs

A range of levers designed to meet the unique design requirements of every project.

Standard Finishes

Brown	(BRN)
Gold	(GLD)
Chrome Plate	(CP)
Polyester Powdercoat	(PPC)
Satin Chrome	(SC)
Silver	(SL)

Hakea™ Lever #28

Dimensions:

Length:	121 mm
Projection:	46 mm
F= Finger clearance:	24 mm

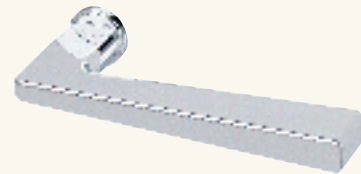
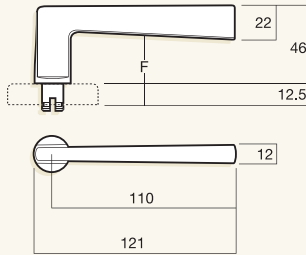

Description:

The Hakea with a blend of straight lines and tapered edges makes a bold statement.

*Design Registered Australia/New Zealand

Acacia™ Lever #29

Dimensions:

Length:	121 mm
Projection:	44 mm
F= Finger clearance:	29 mm

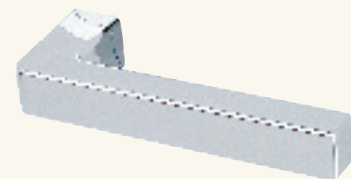
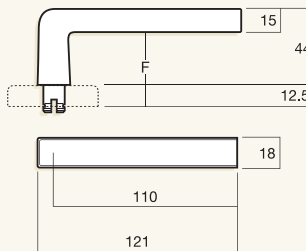

Description:

The simplistic straight lines of the Acacia gives a sharp modern look.

*Design Registered Australia/New Zealand

Lilly® Lever #31

Dimensions:

Length:	121 mm
Projection:	58 mm
F= Finger clearance:	46.5 mm

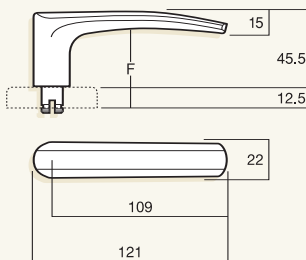

Description:

The strong, smooth lines of Lilly softly taper at the end to give a flowing, modern look.

*Design Registered Australia/New Zealand

Banksia™ Lever #33

Dimensions:

Length:	129 mm
Projection:	59 mm
F= Finger clearance:	37.5 mm

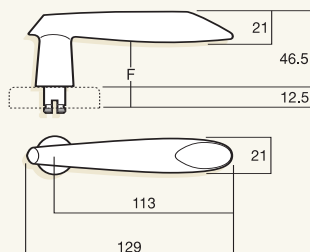

Description:

A unique design gives the Banksia a touch of flair combined with a smooth elegance.

*Design Registered Australia/New Zealand

Daintree® Series Door Furniture

Daintree Lever Furniture (continued)

Daintree Lever Designs

A range of levers designed to meet the unique design requirements of every project.

Standard Finishes

Brown	(BRN)
Gold	(GLD)
Chrome Plate	(CP)
Polyester Powdercoat	(PPC)
Satin Chrome	(SC)
Silver	(SL)

Saltbush® Lever #34

Dimensions:

Length:	120 mm
Projection:	64.5 mm
F= Finger clearance:	42 mm

Description:

Saltbush offers sleek lines which complement the offset curvature of the handle.

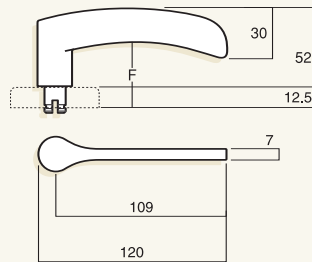

Spinifex® Lever #35

Dimensions:

Length:	134 mm
Projection:	58.5 mm
F= Finger clearance:	42 mm

Description:

Dynamically balanced design combined to accent the sculptured features of Spinifex.

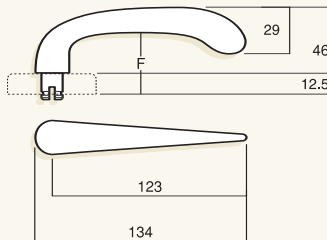

*Design Registered Australia/New Zealand

Mulga® Lever #36

Dimensions:

Length:	122 mm
Projection:	63 mm
F= Finger clearance:	47 mm

Description:

Mulga offers smooth tubular characteristics in an established classic design.

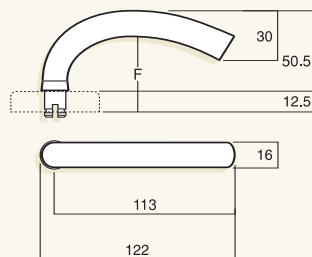

Gidgee® Lever #37

Dimensions:

Length:	132 mm
Projection:	63 mm
F= Finger clearance:	47 mm

Description:

Gidgee combines strength of design with traditional simplicity.

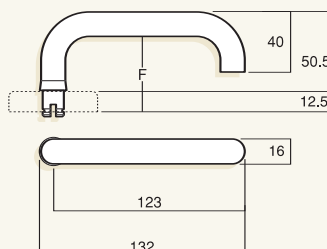

Daintree 3680 Square Series Cylinders & Turn Escutcheons

Standard Finishes

Brown	(BRN)
Gold	(GLD)
Chrome Plate	(CP)
Polyester Powdercoat	(PPC)
Satin Chrome	(SC)
Silver	(SL)

3686 Oval Cylinder Escutcheon

Application:

Designed for use with Lockwood 3570 Series Mortice Locks.

Description:

Practical, secure and pleasing to the eye, this escutcheon has an oval cylinder hole. Features concealed fixing.

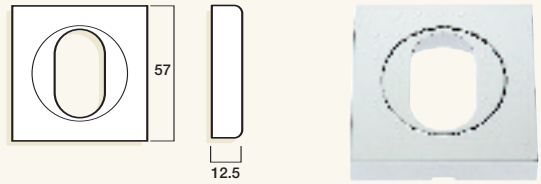

3686E Euro Cylinder Escutcheon

Application:

Designed for use with European Mortice Locks.

Description:

This Euro cylinder escutcheon provides security in an unobtrusive design. Featuring concealed fixing.

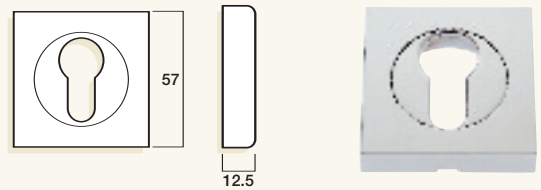

3687 Turn Knob Escutcheon

Application:

Designed for use with Lockwood 3570 Series Mortice Locks and A6208 Tubular Privacy Bolt.

Description:

Complement your round door furniture with this turn for use in all snibbing applications. Features concealed fixing.

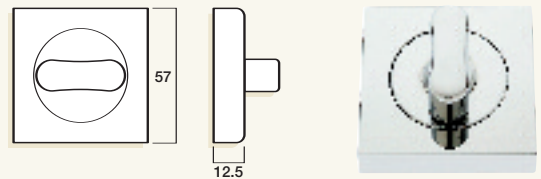

3688 Privacy Turn Escutcheon

Application:

Designed for use with Lockwood 3570 Series Mortice Locks and A6208 Tubular Privacy Bolt.

Description:

Complement your round door furniture with this escutcheon. For use in applications where privacy turn knob access is required, effectively and easily. Features concealed fixing.

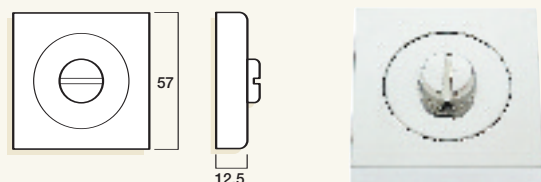

Daintree® Series Door Furniture

Daintree Square Series Accessories

Accessories

Accessories designed to meet all of your functional requirements whether they be residential or semi-commercial in type.

3691 Rose Spacer

Description:

The rose spacer enables the standard Daintree lever set to be retro-fitted onto existing 54 mm holes.

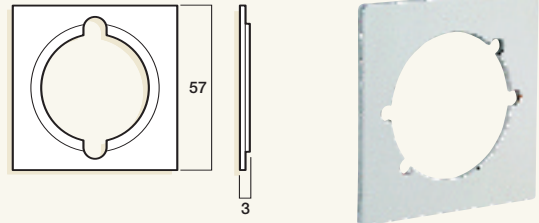

Rose Trim 3680/110

Description:

Rose trim to suit all Daintree series door furniture and escutcheon hardware.

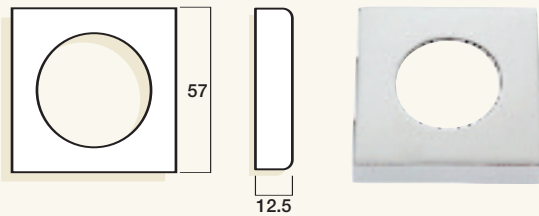

Rose Trim 3686/110

Description:

Rose trim to suit all Daintree series door furniture and escutcheon hardware.

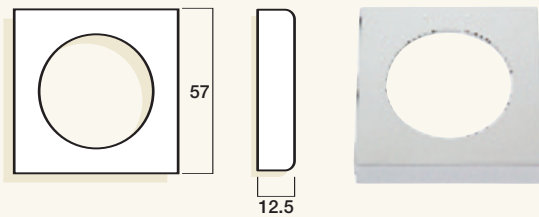

Daintree 3880 Round Series Cylinders & Turn Escutcheons

Round Escutcheons

A range of escutcheons for the fitting of oval and profile cylinders including turns and emergency turns is available in the same wide choice of metal finishes and powdercoatings to complement all Daintree lever furniture installations.

Standard Finishes

Brown	(BRN)
Gold	(GLD)
Chrome Plate	(CP)
Polyester Powdercoat	(PPC)
Satin Chrome	(SC)
Silver	(SL)

3886 Oval Cylinder Escutcheon

Application:

Designed for use with Lockwood 3570 Series Mortice Locks.

Description:

Practical, secure and pleasing to the eye, this escutcheon has an oval cylinder hole. Features concealed fixing.

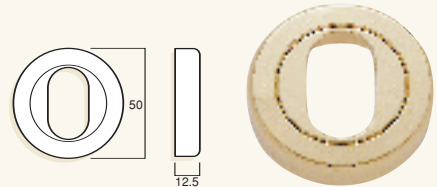

3886E Euro Cylinder Escutcheon

Application:

Designed for use with European Mortice Locks.

Description:

This Euro cylinder escutcheon provides security in an unobtrusive design featuring concealed fixing.

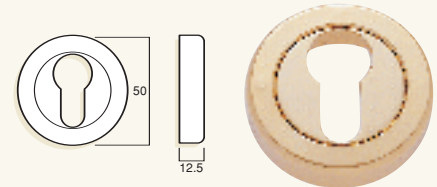

3887 Turn Knob Escutcheon

Application:

Designed for use with Lockwood 3570 Series Mortice Locks and A6208 Tubular Privacy Bolt.

Description:

Complement your round door furniture with this turn for use in all snibbing applications.

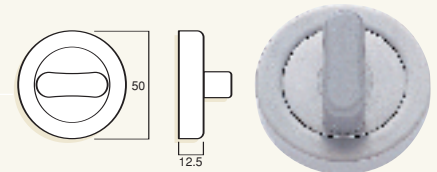

3888 Privacy Turn Escutcheon

Application:

Designed for use with Lockwood 3570 Series Mortice Locks and A6208 Tubular Privacy Bolt.

Description:

Complement your round door furniture with this escutcheon. For use in applications where privacy turn knob access is required, effectively and easily. Features concealed fixing.

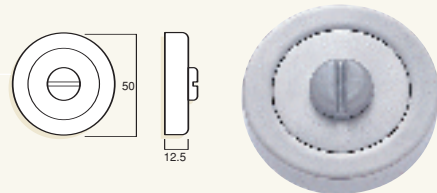

1231* Small Turn Knob Assembly

Application:

Designed for use with Lockwood 3570 Series Mortice Locks and A6208 Tubular Privacy Bolt.

Description:

Complement your round door furniture with this aesthetically pleasing turn escutcheon. For ease of use in all snibbing applications.

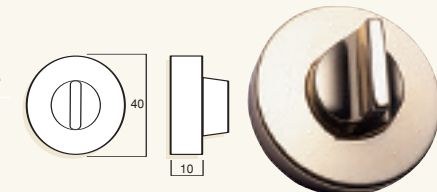

1232* Small Privacy Release Assembly

Application:

Designed for use with Lockwood 3570 Series Mortice Locks and A6208 Tubular Privacy Bolt.

Description:

Complement your round door furniture with this aesthetically pleasing emergency release escutcheon. For use in privacy applications.

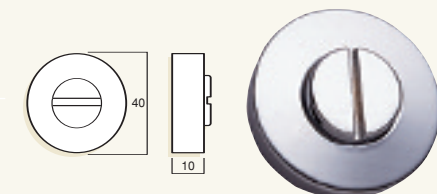

* Note: Finishes for 1231/1232, refer to escutcheon ordering procedures on page 5.

Daintree® Series Door Furniture

Daintree Round Series Accessories

Accessories

Accessories designed to meet all of your functional requirements whether they be residential or semi-commercial in type.

3891 Rose Spacer

Description:

The rose spacer enables the standard Daintree lever set to be retro-fitted onto existing 54 mm holes.

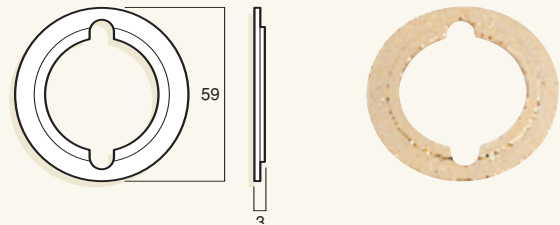

Rose Trim 3880/110

Description:

Rose trim to suit all Daintree series door furniture and escutcheon hardware.

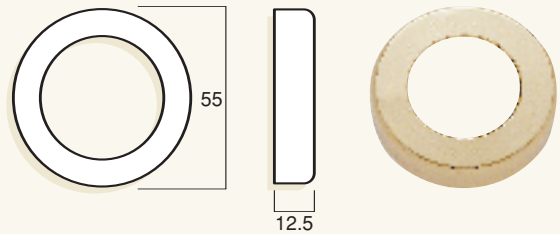

Rose Trim 3886/110

Description:

Rose trim to suit all Daintree series door furniture and escutcheon hardware.

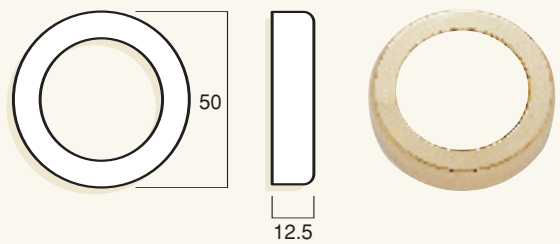

Daintree Accessories

Accessories

Accessories designed to meet all of your functional requirements whether they be residential or semi-commercial in type.

A6208 Privacy Bolt

Description:

Tubular privacy latch for use with tail bar and spindle turn applications.

Finishes:

- Polished Brass (PBP)
- Satin Stainless Steel (SSS)
- Polished Stainless Steel (PSS)

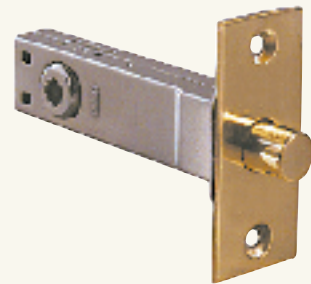
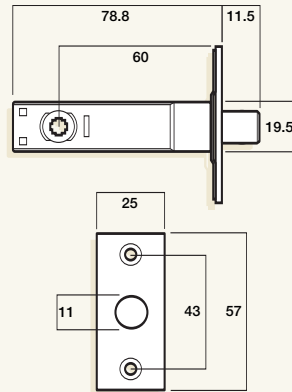

A5250 Tubular Latch

Description:

Tubular latch designed for use with horizontal through fixing door furniture.

Finishes:

- Polished Brass (PBP)
- Satin Stainless Steel (SSS)
- Polished Stainless Steel (PSS)

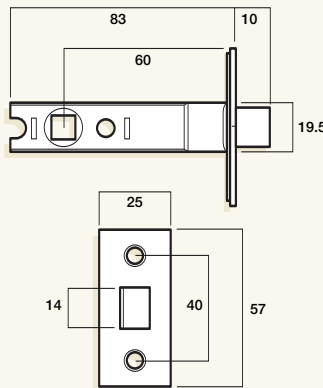

Daintree® Series Door Furniture

Daintree Privacy Adaptors

Description:

The privacy adaptor has a patented built in clutching mechanism which allows the engaged mode to be overridden by use of specified force applied in a single downward action on the lever. This will allow entry in an emergency situation without the use of any type of tool.

Once in this position the latch is automatically held back.

If the door has been fitted with lift-off hinges, the hold-back feature will assist when removing the door in an emergency.

When Safety, Privacy and Convenience is required the Daintree Privacy Adaptor makes good sense all round.

Fixing:

The privacy adaptor can be installed onto any existing Daintree lever set and standard A5250 tubular latch. Instructions, screws and spindle are supplied with every adaptor.

Door Thickness:

Suitable for door thicknesses of 32 to 45 mm.

Standard Finishes:

Chrome Plate	(CP)
Gold	(GLD)
Polyester Powdercoat	(PPC)
Satin Chrome	(SC)
Silver	(SL)

Limiting Dimensions:

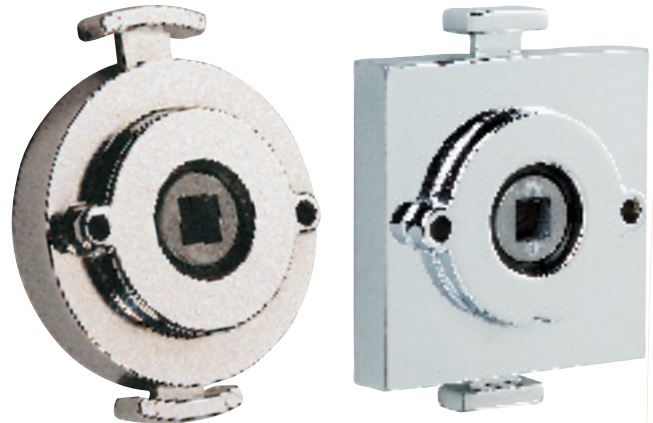
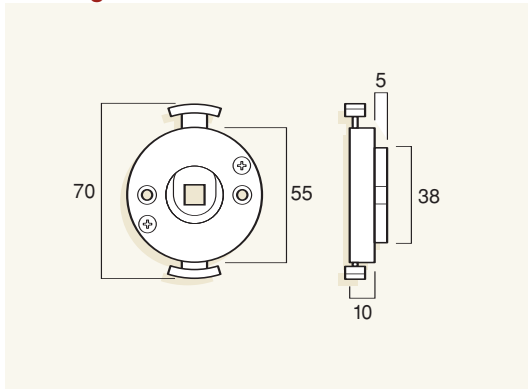

Safety:

A single downward action is required for a quick entry in an emergency. No tool required. Hold-back function will hold back the tubular latch to assist in the removal of a door fitted with lift-off hinges.

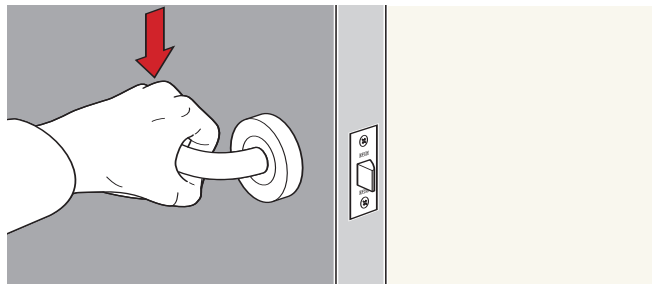

Privacy:

Ergonomic design ensures easy operation of snib in a vertical action for engaging privacy function.

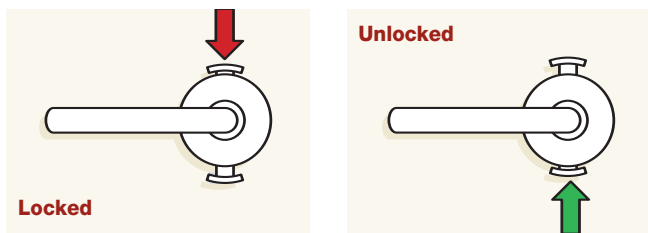

Ordering Procedure:

Finish	
Chrome Plate	CP
Satin Chrome Plate	SC
Gold	GLD
Polyester Powdercoat	PPC
Silver	SL

3890	CP
-------------	-----------

Part Number	
Square Version	3690
Round Version	3890

Convenience:

The Daintree Privacy Adaptor can easily be fitted to existing Daintree Door Furniture using a standard tubular latch (A5250).

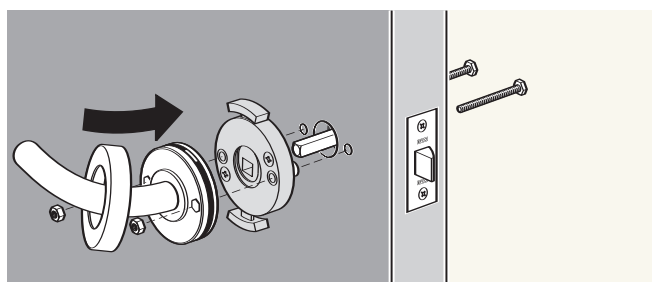



LOCK UP WITH LOCKWOOD

Visit us at: www.assaabloypacific.com

ASSA ABLOY Sales Offices & Authorised Agents in Asia Pacific

Victoria – Head Office

50 Edward Street
Oakleigh VIC 3166
Telephone (03) 8574 3888
Facsimile (03) 8574 3788

Queensland South

450 Sherwood Road
Sherwood QLD 4075
Telephone (07) 3373 5200
Facsimile (07) 3373 5256

Queensland North

Ralph Buck Agencies
15 Mackley Street
Garbutt QLD 4814
Telephone (07) 4779 0177
Facsimile (07) 4775 1480

New South Wales – Commercial

Unit 1/16 Atkinson Road
Taren Point NSW 2229
Telephone (02) 8543 3700
Facsimile (02) 9531 7944

New South Wales – Residential

Unit 5/30 Foundry Road
Seven Hills NSW 2147
Telephone (02) 9620 9111
Facsimile (02) 9620 9055

Abloy Security

5/372 Eastern Valley Way
Chatswood NSW 2067
Telephone (02) 9882 6066

South Australia

182 Magill Road
Norwood SA 5067
Telephone (08) 8364 1930
Facsimile (08) 8364 1931

Western Australia

45 Gladstone Street
East Perth WA 6004
Telephone (08) 9227 9588
Facsimile (08) 9227 8913

Tasmania

23 Antill Street
South Hobart TAS 7000
Telephone (03) 6223 5404
Facsimile (03) 6224 0435

Christchurch

Unit 5, 8 Venture Place
Christchurch New Zealand
Telephone (03) 379 4810
Facsimile (03) 379 4819

Manufacturing Plants

Victoria

50 Edward Street
Oakleigh VIC 3166
Telephone (03) 8574 3888
Facsimile (03) 8574 3788

Queensland

450 Sherwood Road
Sherwood QLD 4075
Telephone (07) 3373 5200
Facsimile (07) 3373 5256

New Zealand

6 Armstrong Road
North Harbour Industrial Estate
Albany, Auckland New Zealand
Telephone +64 (0)9 6224 804
Facsimile +64 (0)9 6224 802

Auckland

9B Mahunga Drive
Mangere Bridge
Auckland New Zealand
Telephone +64 (0)9 634 5590
Facsimile +64 (0)9 634 5589

Wellington

47 Kenepuru Drive
Porirua
Wellington New Zealand
Telephone +64 (0)4 237 0808
Facsimile +64 (0)4 237 0060



Export Department

50 Edward Street
Oakleigh VIC 3166 Australia
Telephone +61 (0)3 8574 3888
Facsimile +61 (0)3 8574 3789

Asian Offices

ASSA ABLOY – Malaysia

ASSA ABLOY – Singapore

ASSA ABLOY – Thailand

ASSA ABLOY – Hong Kong

ASSA ABLOY – Shanghai

ASSA ABLOY – Beijing

ASSA ABLOY – Korea

Contact the Export Department,
Australia for details.

Worldwide Distributors

Contact the Export Department,
Australia for details.

ASSA ABLOY

Lockwood Guarantee

ASSA ABLOY Australia Pty Limited ("ASSA ABLOY") guarantees its Lockwood products against defects in workmanship and materials. If within the normal working life of a product it is found to be defective, ASSA ABLOY will supply the same or equivalent product free of charge.

All electrical and electronic components used in ASSA ABLOY's range of products excluding batteries are guaranteed for a period of 12 months from the date of proof of purchase, unless stated otherwise.

ASSA ABLOY assumes no liability under the guarantee for the following:

1. Improper installation or failure to follow fitting instructions.
2. Failure due to improper maintenance.
3. Failure due to fair wear and tear.
4. Indirect or consequential loss or damage.
5. Cost of removal and/or replacement.

6. Cost of freight and/or travelling time.

7. The plated finishes Florentine Bronze, Architectural Bronze, Polished Brass, Gold and Satin Brass, "which" are classified as soft finishes. As deterioration is possible under some environmental conditions, these finishes are excluded from this guarantee.

8. Any modification or repairs to a product, as supplied, unless authorised by ASSA ABLOY Australia Pty Limited.

9. Use of replacement parts other than authorised parts.

10. Malfunction or failure of the product due to the use of non-genuine Lockwood parts.

11. Malfunction or failure of the product due to the use of non-specified batteries.

Nothing in the ASSA ABLOY Australia Pty Limited guarantee excludes, restricts or modifies any condition, warranty, right or liability implied or protected by law where to do so would render the Guarantee, or any part of it, void.

